

Data Sheet



Article number: 2307082231

Description: E+G Direct drive position indikator
DD52R-AN-0004.0-D-C3 (Grey)

Measures

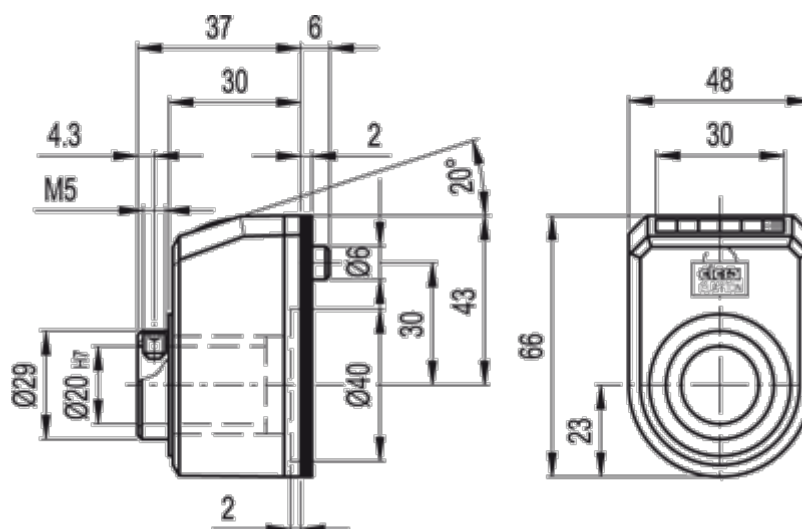

Max rpm = 625